

Get Set Go BI Mobile

SAP BusinessObjects™



AGENDA

Why Mobile?

- Need for Mobility

BI 4.1

- Introduction to BI Portfolio

SAP BI Mobile

- Why HTML 5? SAP BI Mobile on iDevices
- BO Tools used for development

Ipad Demo

- BI portfolio on iPad

Mobile Strategy

- Best Practices & Deployment Options

Q & A

- #askQuestions @Rajeshbipro #PGHBOUG

Why Mobile?

Key Trends shaping the future of BI



of BI consumed on handhelds in 2013



of information needs handled by end users



Nucleus Research, Gartner, Forbes, Fortune Magazine, Forrester
The Forrester Wave™: Self-Service Business Intelligence Platforms, Q2 2012

Mobilizing the SAP BI Suite

Reporting



Dashboard & Apps



Self Service



Web Intelligence



Design Studio



Explorer



Crystal Reports

Dashboards

Lumira

Solution Overview

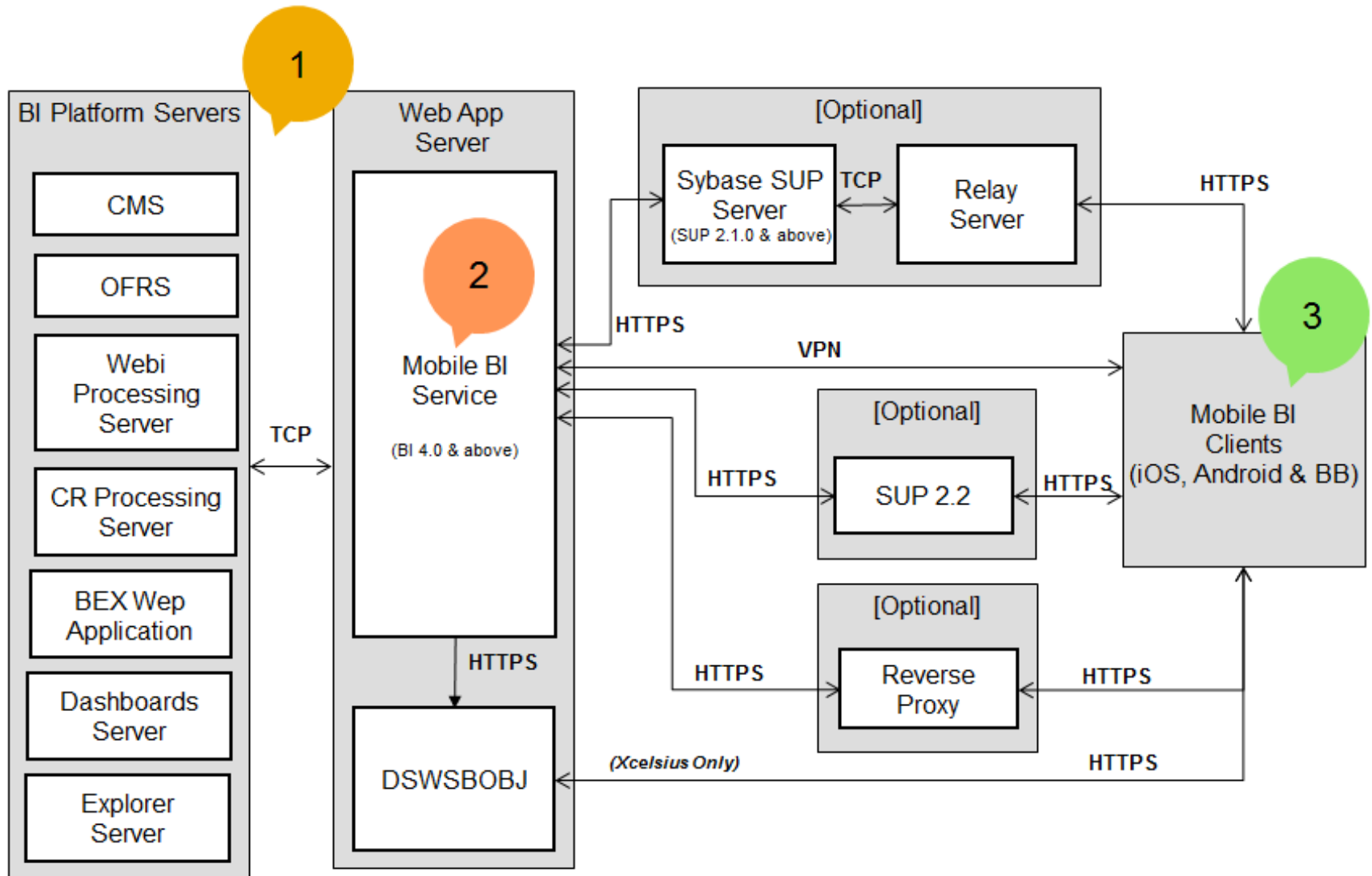

CMC Security Settings

Central Management Console

Applications

Manage Actions

Application Name

- Dashboards
- Desktop Intelligence
- Discussions
- Explorer
- HANA Authentication
- Information Design Tool
- Information Steward Application
- Monitoring Application
- Multitenancy management tool
- Open Document
- Platform Search Application
- Promotion Management
- Report Conversion Tool
- RESTful Web Service
- SAP BusinessObjects Mobile**
- Translation management tool
- Universe design tool

Client Settings

Hide Navigation

Properties

Client Settings

User Security

Mark for deletion	Key	Value
<input type="checkbox"/>	savePassword	false
<input type="checkbox"/>	offlineStorage	false
<input type="checkbox"/>	offlineStorage.ttl	365
<input type="checkbox"/>	offlineStorage.appPwd	true

+ Add More...

Specific Rights for SAP BusinessObjects Mobile	Implicit Value					
Log on to SAP BusinessObjects Mobile application.	Granted	<input checked="" type="checkbox"/>	<input type="checkbox"/>	<input type="checkbox"/>	<input checked="" type="checkbox"/>	<input checked="" type="checkbox"/>
Save documents to the local store of a device.	Granted	<input type="checkbox"/>	<input type="checkbox"/>	<input checked="" type="checkbox"/>	<input checked="" type="checkbox"/>	<input checked="" type="checkbox"/>
Send documents from device as an email.	Granted	<input type="checkbox"/>	<input type="checkbox"/>	<input checked="" type="checkbox"/>	<input checked="" type="checkbox"/>	<input checked="" type="checkbox"/>
Subscribe to document alerts.	Granted	<input type="checkbox"/>	<input type="checkbox"/>	<input checked="" type="checkbox"/>	<input checked="" type="checkbox"/>	<input checked="" type="checkbox"/>

BI Launch Pad Integration

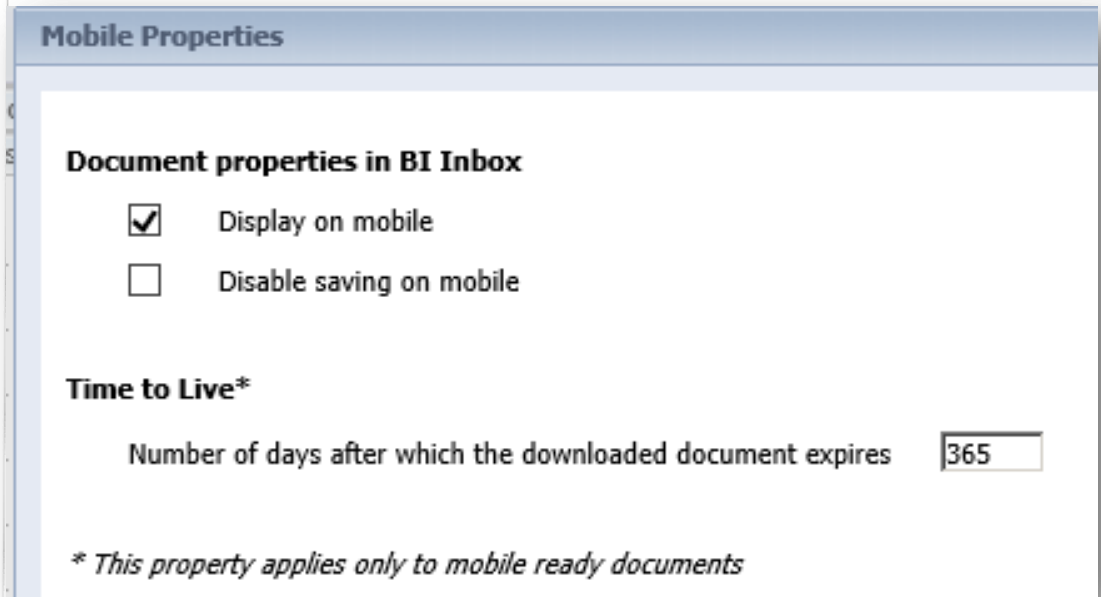
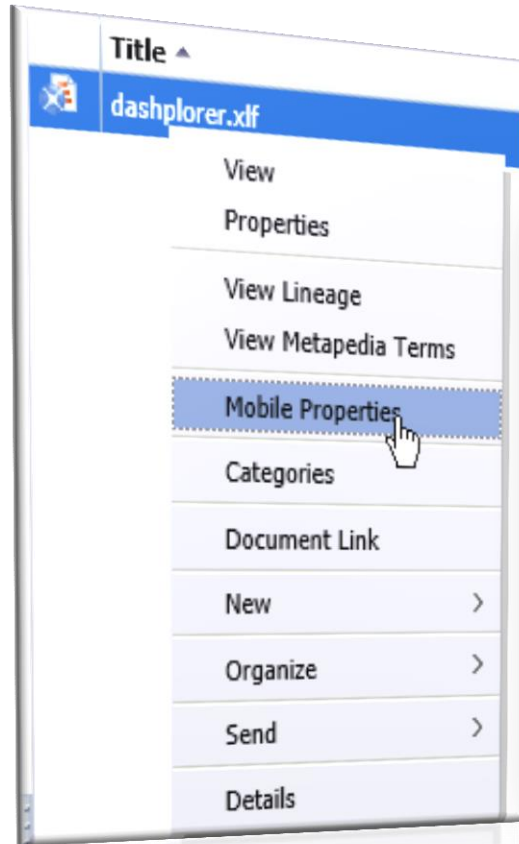

One App for All BI Content

Available currently only on
BI 4.1 Platform

SAP BusinessObjects
Mobile



SAP BusinessObjects
Mobile



SAP BusinessObjects
Explorer



SAP BusinessObjects Mobile SDK



Customize

Branding
Onboarding
Customize product features

Extend

Extend the application with new charts and visualization



Integrate & Embed

Integrate with the 3rd party security tools to enforce the corporate policies and enhance security
Embed BI content within 3rd party iOS apps

Distribute

Distribute through Enterprise App Store, MDM tools or upload the customized app to App Store





Why HTML 5?

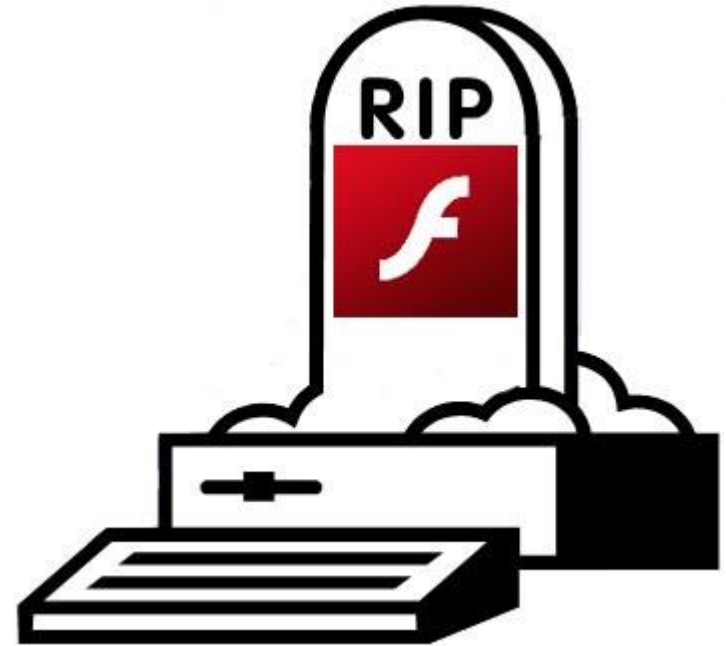

Why Only iPad?



Reporting

Dashboard & Apps

Self Service

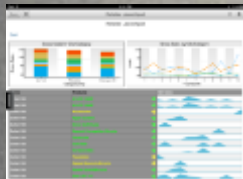

WebI



Crystal



Xcelsius



Design Studio



Explorer



Lumira



Secure your application

- Apple Touch ID can be used to secure your analytics app and documents
- Use Touch ID instead of typing application password
- Protect sensitive data in your BI documents by securing it with Touch ID

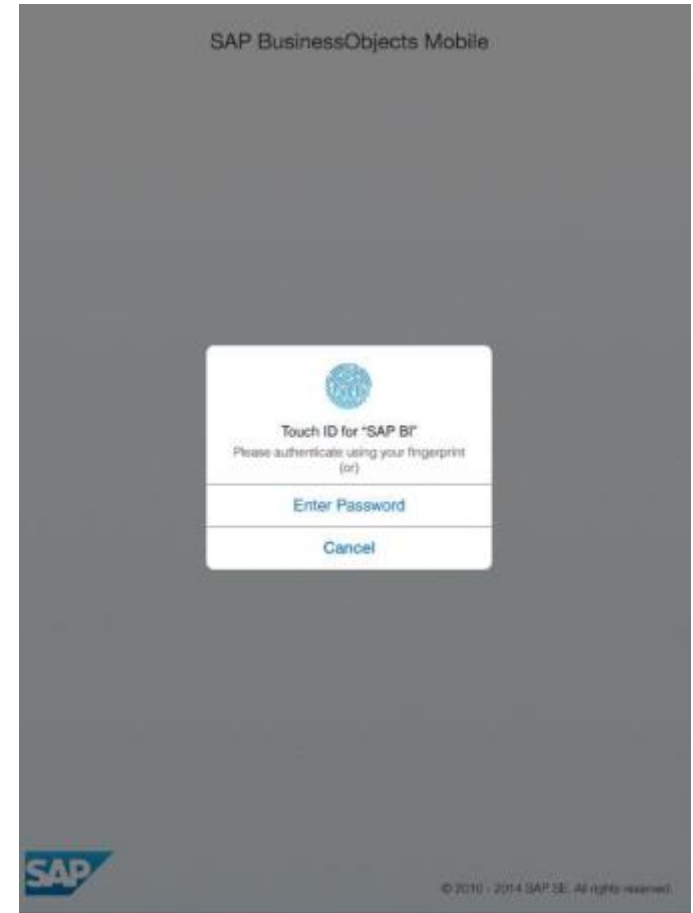

Supports PDF as new Content Type

- PDF documents stored on BOE server can now be accessed within MOBI
- Password protected PDF document is supported
- Works in online & offline mode
- Supported both on iOS and Android

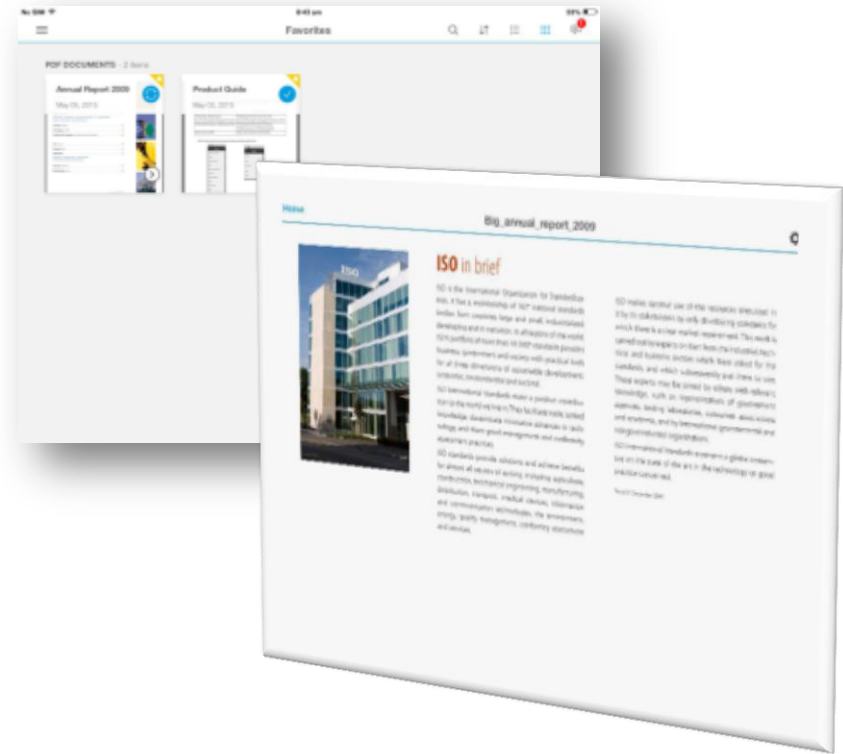

Automatic Download

- On establishing connection for the first time, documents will be automatically downloaded to the mobile device without any user intervention
- Documents tagged to “Featured” category on BI platform will be marked for auto download

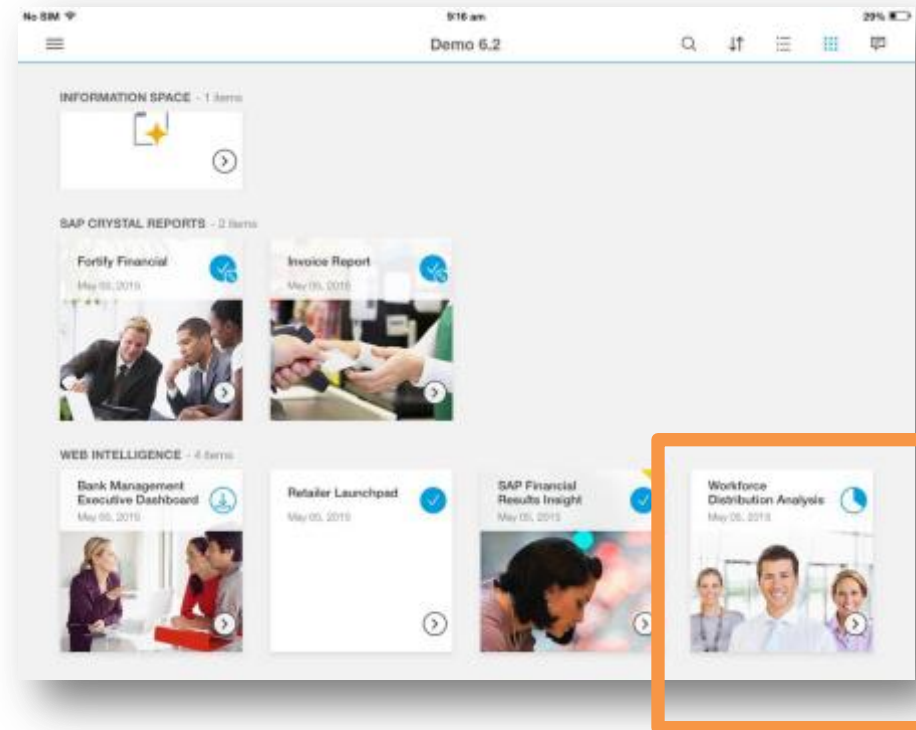

Dashboard Designer Performance Enhancements for Mobile

Dashboards re-published using BI 4.1 SP06 designer will have enhanced performance on mobile

- Reduced packet size from server
- Static components of the dashboards are displayed first & in background connection will be established to pull data & refresh the content

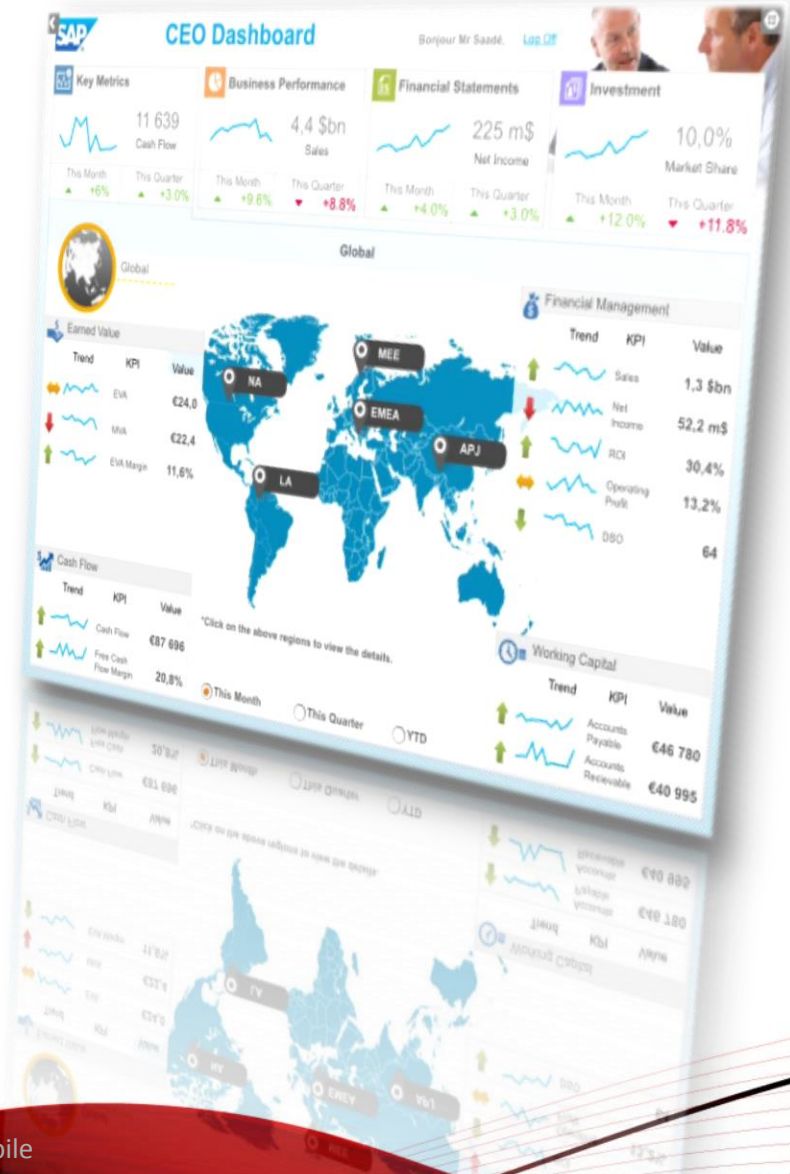

Prefer-cache Option

- An option to enable “Prefer Cache” for downloaded dashboards
- When it is set to true, application loads the dashboard content from cached content even when app is in connected mode. This option is available via client settings property on mobile server
“feature.dashboards.prefer.cache.enabled=true”

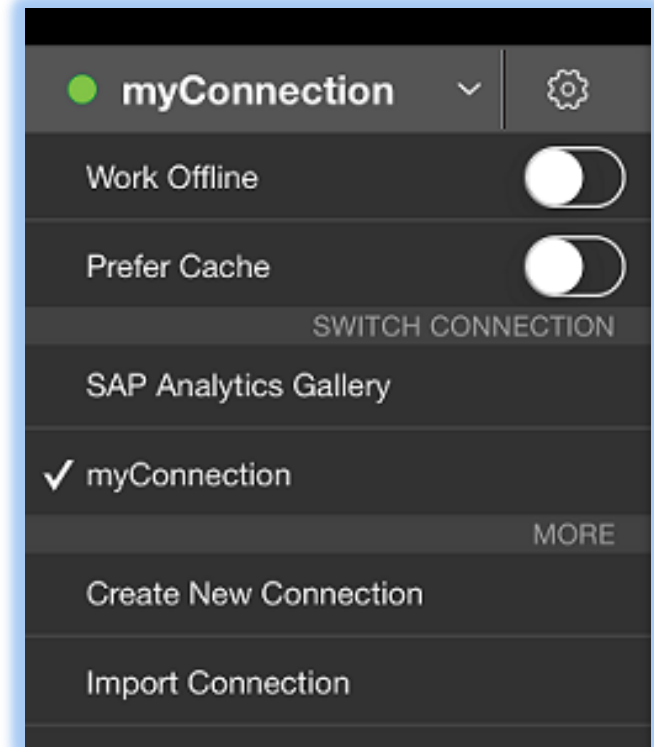

Delivering it to Users via URL

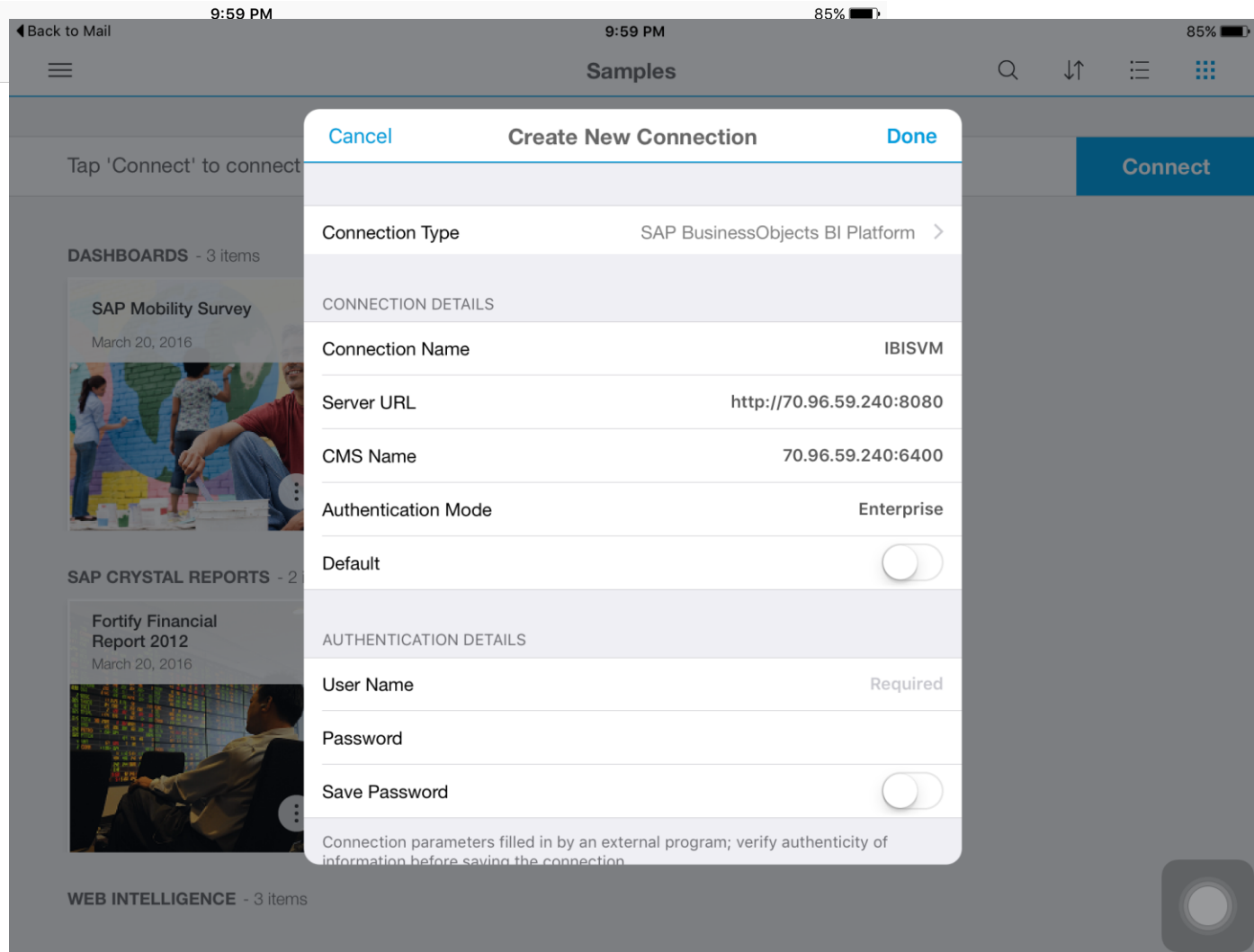
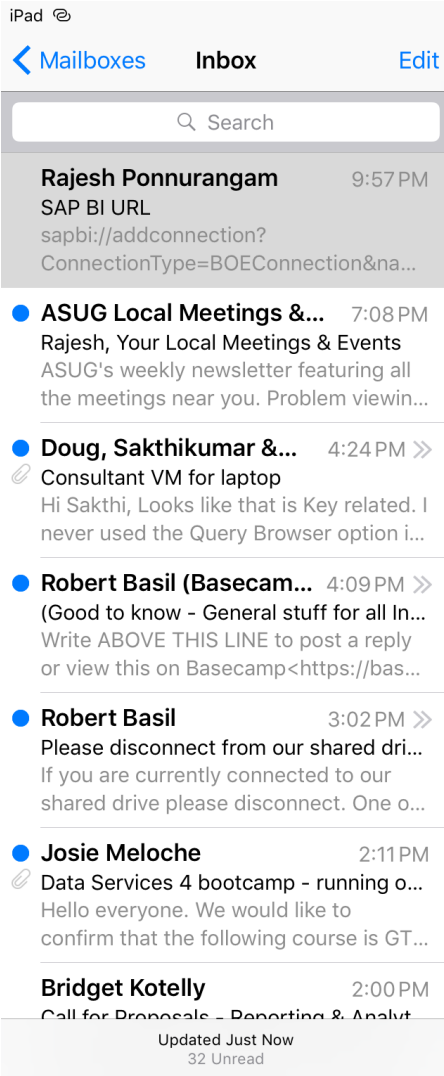

Best Practices

- Quick Turnaround



RETURN ON INVESTMENT



- Existing dashboards



Best Practices

- The Future is HTML 5



Best Practices

USDCAD Exchange Rate

Year	Quarter	Rate	High (est)	Low (est)
	2	2.88%	-1.01	-0.99
	3	(4.41%)	0.99	0.97



Best Practices

- Stop the Apple Vs Android battle







#askQuestions
@infosolinc
@rajeshbipro
#SABOUC

Special Announcements!

Save the Date: IBIS 2016 | June 20 – 22nd | Carlsbad, CA

